

FEATURES

- ◆ Small footprint
- ◆ SIP6 package
- ◆ Temperature range: -40°C~+85°C
- ◆ 1KVDC isolation
- ◆ No Heat sink required
- ◆ No external component required
- ◆ Internal SMD Construction
- ◆ Industry standard pinout
- ◆ RoHS Compliance

MODEL SELECTION

D^①05^②05^③05^④X^⑤M^⑥-1W^⑦

- ① Product Series
- ② Input Voltage
- ③ The 1st Output Voltage
- ④ The 2nd Output Voltage
- ⑤ Fixed Input
- ⑥ Mini SIP Package Style
- ⑦ Rated Power

APPLICATIONS

The D-XM-1W Series are specially designed for applications where a group of polar power supplies are isolated from the input power supply in a distributed power supply system on a circuit board.

These products apply to:

- 1) Where the voltage of the input power supply is fixed (voltage variation $\leq \pm 10\%$);
- 2) Where isolation is necessary between input and output (isolation voltage $\leq 1000\text{VDC}$);
- 3) Where the regulation of the output voltage and the output ripple noise are not demanding. Such as: purely digital circuits, ordinary low frequency analog circuits, and IGBT power device driving circuits.



MICRODC RESERVES THE COPYRIGHT

PRODUCT PROGRAM

Part Number	Input		Voltage (VDC)	Output		Efficiency (% Typ)
	Voltage (VDC)			Current (mA)		
	Nominal	Range	Max	Min.		
D030505XM-1W	3.3	2.97-3.63	5	100	10	70
D050303XM-1W	5	4.5-5.5	3.3	152	15	62
D050505XM-1W	5	4.5-5.5	5	100	10	71

COMMON SPECIFICATIONS

Item	Test Conditions	Min.	Typ.	Max.	Units
Storage humidity range				95	%
Operating temperature		-40		85	°C
Storage temperature		-55		125	
Lead temperature	1.5mm from case for 10 seconds			300	
Temp. rise at full load			15	25	
Short circuit protection*				1	S
Cooling		Free air convection			
Case material		Plastic (UL94-V0)			
MTBF		3500			K hours
Weight			1.4		g

*Supply voltage must be discontinued at the end of short circuit duration.

ISOLATION SPECIFICATIONS

Item	Test Conditions	Min.	Typ.	Max.	Units
Isolation voltage (Vin/Vout)	Tested for 1 minute and 1mA max	1000			VDC
Isolation voltage (Vo1/Vo2)	Tested for 1 minute and 1mA max	1000			VDC
Isolation resistance (Vin/Vout)	Test at 500VDC	1000			MΩ
Isolation resistance (Vo1/Vo2)	Test at 500VDC	1000			MΩ
Isolation capacitance (Vin/Vout)			30		pF
Isolation capacitance (Vo1/Vo2)			30		pF

OUTPUT SPECIFICATIONS

Item	Test Conditions	Min.	Typ.	Max.	Units
Output power		0.1		1	W
Line regulation	For Vin change of 1%			± 1.5	%
Load regulation	10% to 100% load (3.3V output)		15	20	%
Load regulation	10% to 100% load(5V output)		12.8	15	%
Output voltage accuracy		See tolerance envelope graph			
Temperature drift	100% full load			± 0.03	%/°C
Ripple & Noise*	20MHz Bandwidth		75	100	mVp-p
Switching frequency	Full load, nominal input		130		KHz

*Test ripple and noise by "Parallel cable"method. See detailed operation instructions at Testing of Power Converter section, application notes.

TYPICAL CHARACTERISTICS

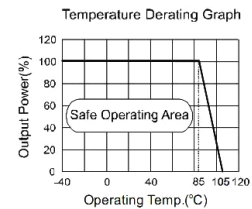
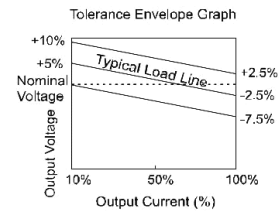

APPLICATION NOTE

Requirement on output load

To ensure this module can operate efficiently and reliably, During operation, the minimum output load could not be less than 10% of the full load. If the actual output power is very small, please connect a resistor with proper resistance at the output end in parallel to increase the load , or use our company products with a lower rated output power.

Recommended circuit

If you want to further decrease the input/output ripple , an "LC" filtering network may be connected to the input and output ends of the DC/DC converter, see (Figure 1).

It should also be noted that the inductance and the frequency of the "LC" filtering network should be staggered with the DC/DC frequency to avoid mutual interference. However , the capacitance of the output filter capacitor must be proper. If the capacitance is too big,a startup problem might arise. For every channel of output , provided the safe and reliable operation is ensured , the recommended capacitance of its filter capacitor sees (Table 1).

Output Voltage Regulation and Over-voltage Protection Circuit

The simplest device for output voltage regulation, over-voltage and over-current protection is a linear voltage regulator with overheat protection that is connected to the input or output end in series (Figure 2).

Overload Protection

Under normal operating conditions, the output circuit of these products has no protection against overload.The simplest method is to connect a self-recovery fuse in series at the input end or add a circuit breaker to the circuit.

No parallel connection or plug and play

RECOMMENDED CIRCUIT

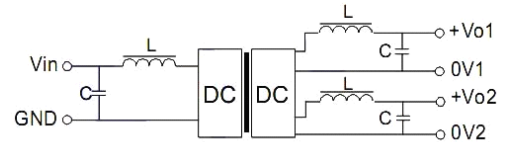

(Figure 1)

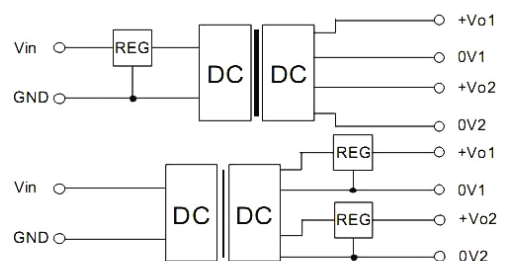

(Figure 2)

EXTERNAL CAPACITOR TABLE (TABLE 1)

Vin(VDC)	Cin(μF)	Cout(μF)	Vout(VDC)
3.3/5	4.7	3.3/5	4.7

It's not recommended to connect any external capacitor in the application field with less than 0.5 watt output.

OUTLINE DIMENSIONS & FOOTPRINT DETAILS

MECHANICAL DIMENSIONS

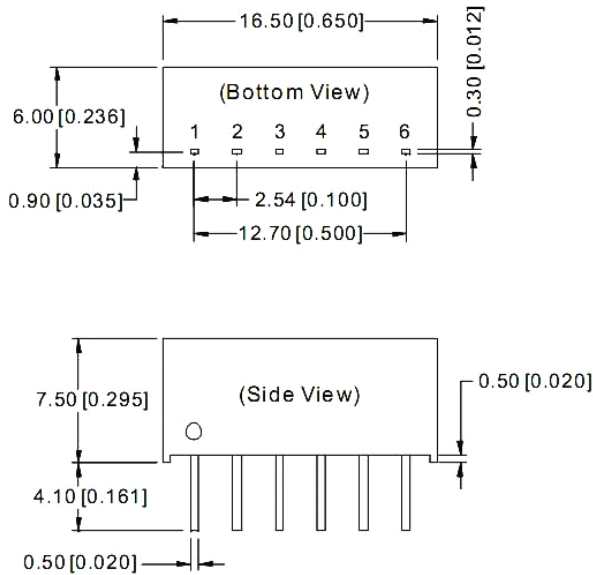

Note:

Unit:mm[inch]

Pin section tolerances:±0.10mm[±0.004inch]

General tolerances:±0.25mm[±0.010inch]

FOOTPRINT DETAILS	
Pin	Function
1	Vin
2	GND
3	Vo1
4	0V1
5	Vo2
6	0V2

RECOMMENDED FOOTPRINT

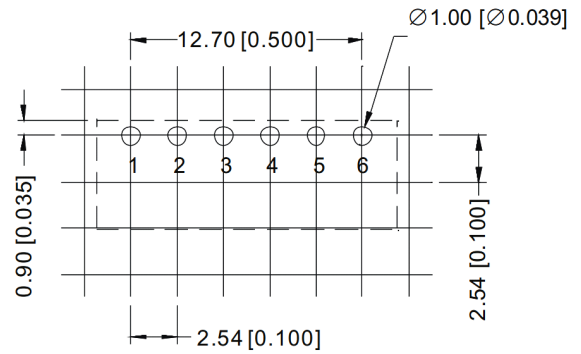

TUBE OUTLINE DIMENSIONS

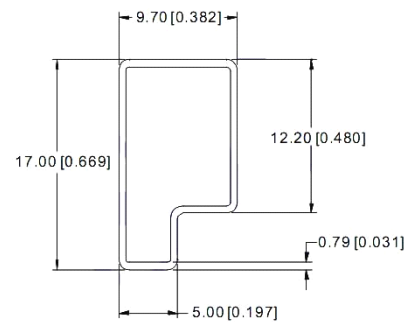

Note:

Unit :mm[inch]

General tolerances:±0.50mm[±0.020inch]

L=530mm[20.866inch] Tube Quantity: 30pcs

L=220mm[8.661inch] Tube Quantity: 11pcs

RoHS COMPLIANT INFORMATION

This series is compatible with RoHS soldering systems with a peak wave solder temperature of 300° C for 10 seconds. The pin termination finish on the SIP package type is Tin Plate, Hot Dipped over Matte Tin with Nickel Preplate. The DIP types are Matte Tin over Nickel Preplate. Both types in this series are backward compatible with Sn/Pb soldering systems.

REACH COMPLIANT INFORMATION

This series has proven that this product does not contain harmful chemicals, it also has harmful chemical substances through the registration, inspection and approval.